

# BOWMAN®



*Celebrating 40 years since 1971*

## 2011-2012 CATALOG

# Dispensers

## Personal Protection Equipment Storage & Dispensing

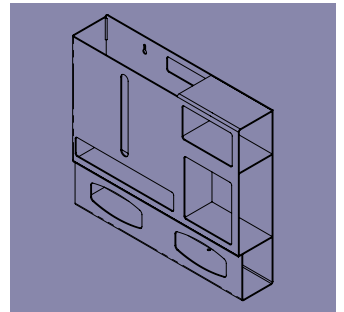
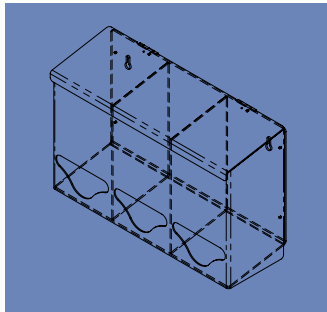
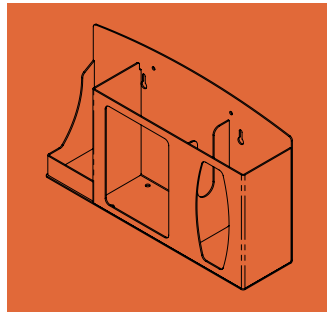
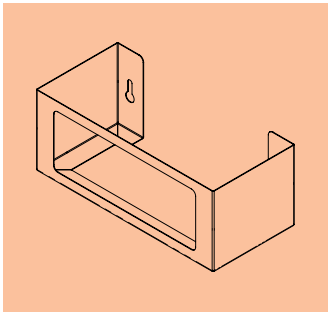
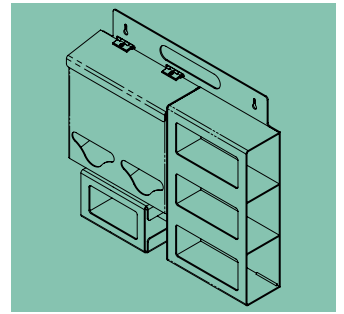
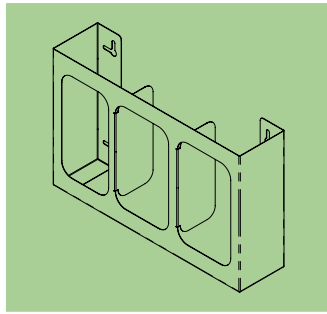

Health Care ■ Food Service ■ Industrial ■ Safety



## Distributors

### Easy To Order



PHONE  
360-435-5005

FAX  
360-435-5277

EMAIL  
customerservice@  
bowmandispensers.com

## End Users

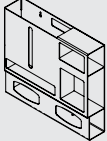
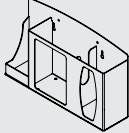
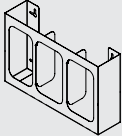
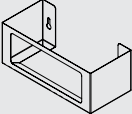
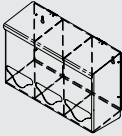
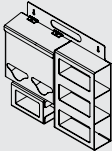
**BOWMAN**® sells exclusively to a national network of distributors. Contact your distributor directly to purchase **BOWMAN**® products. For a listing of our current distributors, please visit our website at [www.BowmanDispensers.com](http://www.BowmanDispensers.com).

	Protection Organizers and Accessories ..... 3 - 10
	Respiratory Hygiene Stations and Kiosk Stands ..... 11- 16
	Glove Dispensers ..... 17 - 20
	Face Mask Dispensers ..... 21- 24
	Bulk Dispensers ..... 25 - 26
	Specialty Dispensers ..... 27- 30
	Product Index ..... 31 - 49

### 3 Protection Organizers



**LD-070**  
Holds flat pack gowns, three boxes of gloves, one box of face masks, and one box of face shields



**LD-007**  
Holds flat pack gowns, three boxes of gloves, and one box of face masks



**LD-063**  
Holds gowns in two compartments, two boxes of gloves, and one box of face masks



**LP-004**  
Holds one box of face masks, three boxes of gloves, and has two bulk storage bins

#### Versatility

Protection Organizers are designed to hold Personal Protection Equipment (PPE) to protect healthcare providers. Quick access to PPE including gloves, face masks, and gowns makes it easier to meet compliance requirements.

Protection Organizers can be easily customized with accessories such as glove dispensers, caddies, sign holders, and door hangers ensuring you have the protective equipment available when and where you need it.

**LD-037**

Holds gowns, two boxes of gloves, face masks, and face shields

All consumable items are for demonstration purposes only and not included with the dispensers.

**Convenience**

Protection Organizers provide a convenient and economical alternative to isolation carts for standardizing the location of PPE supplies. Organizers can be mounted in high traffic, visible locations outside patient rooms,

hung on walls or patient doors. Generally mounted at eye level, they allow the right combination of PPE to be available at all times. The quartz color makes them attractive in any setting.

## 5 Protection Organizers

### Specialty Protection Organizers and Gown Holders

#### 4" Deep Protection Organizers - ADA Compatible



#### **LD-062**

Holds gowns in two compartments, three boxes of gloves, has two bulk face mask sections, and an additional shelf for medical supplies



#### **LD-064**

Holds gowns, three boxes of gloves, face masks in bulk, and contains a built-in storage caddy



#### **PS005-0212**

Holds thumbs-up gowns in bulk quantity, two boxes of gloves, and two boxes of face masks, with a built-in caddy for additional medical supplies

#### Gloveless Organizers



#### **PS007-0212**

Holds flat pack gowns in bulk and thumbs-up gowns in the box or in bulk quantity, one box of face shields, and has two built-in caddies to hold wet wipe and hand gel dispensers



#### **PS003-0212**

Holds gowns, one box of face masks, and one box of face shields



#### **LD-040**

Holds gowns, one box of face masks, and one box of face shields

### Laundered Gown Organizer



**LD-067**  
Holds laundered gowns, two boxes of gloves, and one box of face masks

### Dental Organizer



**MD-100**  
Holds three boxes of gloves, two boxes of face masks, quarter fold towels and patient bibs both in bulk quantity

### Gown Dispensers



**RP-030**  
Holds a box of disposable isolation gowns



**RP-011**  
Holds gowns or aprons

# 7 How to Choose a Protection Organizer

Protection Organizer	Permanently Mounted / Portable	4" Deep Unit	Reusable / Launderable Gowns	Disposable - Flat Pack Gowns	Disposable - Blue Gowns	Gowns - Single	Gowns - Double	Isolation Sign Holder
LD-007	•			•		•		
LD-037	•		•	•	•	•		•
LD-062	•	•	•	•			•	•
LD-063	•			•	•		•	•
LD-064	•	•	•	•		•		•
LD-067	•		•					•
LD-070	•			•		•		
PS005-0212	•	•			•		•	•
PS007-0212	•			•	•		•	

## Mounting Options for Protection Organizers

### Firedoors



#### MB-450

Holds the protection organizer at adjustable heights  
 Attaches to the top of a fire door  
 Quartz powder coated metal

### Glass Doors



#### MB-500

Window J-Hook  
 Attaches to glass with double-sided, semi-permanent tape  
 Quartz powder coated metal



Gloves - Double	Gloves - Triple	Gloves - Quad	Face Masks Earloop Single	Face Masks Earloop Double	Face Shield Masks	Cone Shaped Face Masks	Storage Add On	Storage Built in
	●	Add GD-013	●				MP-015, MP-042, MP-085	
●	Add GD-011 or GD-111	Add GD-012	●		●		MP-015, MP-042, MP-085	GD-111
	●			●				●
●	Add GD-013		●				MP-015, MP-042, MP-085	
	●		●					●
●	Add GD-013		●				MP-015, MP-042, MP-085	
	●	Add GD-013	●		●		MP-015, MP-042, MP-085	
●				●				●
			●		●	●	MP-015, MP-042, MP-085	●

Wall or Door



**MB-510**

Wall/Door J-Hook  
Keyholes for mounting  
Quartz powder coated metal

Standard Size Doors



**MB-600**

12" door hanger that hooks over the top of the door  
Quartz powder coated metal

Tall Doors



**MB-601**

19" door hanger that hooks over the top of the door  
Quartz powder coated metal



**LD-037**

**Protection Organizer**

*Shown with Protection Organizer accessories GD-111, MP-047, and MP-085*

## Customize Your Organizer

### Clip-On Caddies

- Clip-on design in various sizes holds items such as N-95 masks, safety glasses, bags, wet wipe canisters, gloves, etc.
- May be used with protection organizers that are 4" deep or greater



GD-013



MP-015



MP-042



MP-085

### Undermount Caddies

- Available in single, double, or single with additional shelf to hold medical supplies
- Attaches to the bottom of protection organizer LD-037
- Made of quartz ABS plastic



GD-011



GD-012



GD-111

### Sign Holders

- Clips onto the front of a protection organizer
- Vertical layout provides for 8 1/2" x 11" isolation signage
- Made of clear PETG plastic

### Benefits of Customization

Customizing your Bowman protection organizer gives you added accessibility to the personal protection equipment (PPE) you need. Ready availability to PPE assists your efforts in preventing infection and remaining compliant with infection prevention standards.

Download free Cover Your Cough signage by visiting our website at [www.BowmanDispensers.com](http://www.BowmanDispensers.com)



MP-047

# 11 Respiratory Hygiene Stations, Kiosk Stands, & Accessories



## **Respiratory Hygiene Station RS001-0212**

*Shown with sign holder  
MP-070 (sold separately)*

**Comply with the CDC  
guidelines and take  
precautions to prevent  
the transmission of  
respiratory infections**

Download free Cover Your Cough  
signage by visiting our website at  
[www.BowmanDispensers.com](http://www.BowmanDispensers.com)

### **CDC Recommendations\***

To prevent the transmission  
of respiratory infections

**1**

#### **Visual Alerts**

Post visual alerts at the entrances to healthcare facilities, including emergency departments, physician offices, clinics, etc. ○-----

**2**

#### **Cleaning Hands**

Use of antiseptic handwash if a sink for hand washing is not available. ○-----

**3**

#### **Wearing Face Masks**

Wear a mask if coughing. Masks available for visitor use. ○-----

**4**

#### **Using Tissues**

Cover the nose and mouth with a tissue when coughing or sneezing and properly dispose of them after use. ○-----



\*This information is based on the Guideline for Isolation Precautions: Preventing Transmission of Infectious Agents in Health-care Settings. Recommendations of the Healthcare Infection Control Practices Advisory Committee (HICPAC), CDC.

All consumable items are for demonstration purposes only and not included with the dispensers.

# 13 Respiratory Hygiene Stations, Kiosk Stands, & Accessories

## Protecting Ports of Entry

### Non-locking



**RS001-0212**

Non-Locking Respiratory Hygiene Station shown with optional sign holder MP-070 (*sold separately*)



**FD-111**

Non-Locking Respiratory Hygiene Station shown with optional sign holder MP-070 (*sold separately*) and a hand-gel dispenser (*not included*)

### Locking



**FD-062**

Locking Respiratory Hygiene Station shown with optional sign holder MP-070 (*sold separately*)



**FD-112**

Locking Respiratory Hygiene Station shown with optional sign holder MP-070 (*sold separately*) and a hand-gel dispenser (*not included*)

**ED-097**  
**Infection Prevention Organizer**  
*Shown with sign holder*  
*MP-075 (included)*



**WD-015**  
**Hand Sanitizing**  
**Dispensing Station**  
*Shown with hand gel*  
*dispenser (not included)*



All consumable items are for demonstration purposes only and not included with the dispensers.

## Public Area Protection

### Accessibility

Providing a versatile option for standardizing the location of infection prevention supplies, Respiratory Hygiene Stations can be placed in high traffic locations such as lobbies and entryways, hung on walls or set on counters.

### Convenience

Designed to hold a wide variety of supplies from various manufacturers and placed where infection prevention supplies are needed most – at ports of entry.

### Cost Effectiveness

Infectious outbreak investigations and staff absenteeism are very costly. Bowman Respiratory Hygiene Stations provide the items needed to support your efforts in preventing the transmission of infections.

## 15 Respiratory Hygiene Stations, Kiosk Stands, & Accessories

**MP-070**  
Vertical Sign Holder

**RS001-0212**  
Respiratory  
Hygiene Station

**KS010-0412**  
Kiosk Stand



**RS001-0212** Accommodates either hand sanitizer gel or hand sanitizer wipes



**KS010-0412 Compatible With Multiple Units**

**Infection Prevention Organizers**



**ED-097**



**FD-068**

**Hand Hygiene Stations**



**WD-015**  
Shown with hand gel dispenser (not included)

**Respiratory Hygiene Stations**



**RS001-0212**  
Shown with optional sign holder MP-070 (sold separately)

**Sign Holders**



**MP-070**  
Vertical Sign Holder



**MP-075**  
Horizontal Sign Holder

# 17 Glove Dispensers



	<b>Stainless Steel</b>	<b>Powder Coated Metal</b>	<b>PETG</b>	<b>Coated Wire</b>
Single				
	<b>GS-004</b>	<b>GB-001</b>	<b>GP-013</b>	<b>GW-029</b>
Double				
	<b>GS-005</b>	<b>GB-002</b>	<b>GP-014</b>	<b>GW-040</b>
Triple				
	<b>GS-006</b>	<b>GB-003</b>	<b>GP-015</b>	<b>GW-055</b>
Quad				
	<b>GS-060</b>	<b>GB-059</b>	<b>GP-061</b>	<b>GW-065</b>



**GP-043**  
Triple Glove Dispenser  
with dividers

**GS-122**  
Double Glove Dispenser  
with divider

All consumable items are for demonstration purposes only and not included with the dispensers.

## Benefits of Bowman Glove Dispensers

- Most glove dispensers mount both vertically and horizontally.
- Available in stainless steel, powder coated metal, PETG plastic, ABS plastic, Sintra plastic or coated wire.
- Universal fit for most standard glove boxes.
- Most materials available in single, double, triple and quad configurations.
- Minimal to full box visibility.
- Private labeling available for most units.

# 19 Glove Dispensers

## Divided Glove Dispensers

Divided Stainless Steel	Divided PETG Plastic	Divided ABS Plastic
<ul style="list-style-type: none"><li>Minimal box visibility</li><li>Custom logo available</li><li>Saniguard™ antimicrobial coating available</li></ul>	<ul style="list-style-type: none"><li>Full box visibility</li><li>Custom logo available</li><li>Economical</li></ul>	<ul style="list-style-type: none"><li>Minimal box visibility</li><li>Economical</li><li>Standard color: quartz</li></ul>
		
<p><b>GS-122</b></p>	<p><b>GP-042</b></p>	<p><b>GD-042</b></p>
		
<p><b>GS-123 / GS-133*</b> *Saniguard coated</p>	<p><b>GP-043</b></p>	<p><b>GD-043</b></p>

### Benefits of Divided Glove Dispensers

- Multiple boxes stay in place during restocking
- Units mount vertically and horizontally
- Available in stainless steel, PETG and ABS plastic
- Universal fit for most standard healthcare glove boxes
- Quick and easy loading and restocking
- Individual sections for various glove sizes

### BOWMAN® Quad Glove Dispenser

- Horizontal double stacked layout
- Shelf on top provides extra supply storage
- Maximum box coverage
- Made of quartz ABS plastic

## Space Saver Glove Dispensers

### Vertical PETG Plastic

- Full box visibility
- Custom logo available
- Economical



**GP-106**

**GP-107**

### Vertical Powder Coated

- Minimal box visibility
- Custom logo available
- Standard color: white



**GB-067**

**GB-068**

### Vertical Stainless Steel

- Minimal box visibility
- Custom logo available
- Saniguard™ antimicrobial coating available



**GS-108**

**GS-109**



**GL042-0212**

### Benefits of Space Saver Glove Dispensers

- Units mount vertically and horizontally
- Available in stainless steel, PETG and powder coated metal
- Universal fit for most standard healthcare glove boxes

# 21 Face Mask Dispensers



## Face Mask Dispenser Types

### Bulks



**FD-005**

Holds one to three boxes of face masks in bulk quantity



**FD-010**

### Combo Units



**MB-085**

Holds one box of gloves and one box of face masks



**RS001-0212**

Respiratory Hygiene Station

### Ties



**FB-021**

Exact Fit face mask dispenser for most standard size boxes

### Face Shields



**FB-090**



**FP-120**

Exact Fit face shields dispenser for most standard size boxes

### Earloops



**FB-037**



**FP-021**

Exact Fit face mask dispenser for most standard size boxes



**FP-017**  
Single Bulk Dispenser



**FB-037**  
Earloop Face Mask Dispenser

All consumable items are for demonstration purposes only and not included with the dispensers.

## Benefits of Bowman Mask Dispensers

- Bowman face mask dispensers accommodate most major mask manufacturers.
- Rugged designs offering high impact and chemical resistance.
- Made from either transparent PETG plastics or solid powder coated metal materials.
- Universal wall mounting provides for easy installation.
- Access our Face Mask Cross Reference Tools by visiting our website at [www.BowmanDispensers.com](http://www.BowmanDispensers.com).

## 23 Face Mask Cross Reference Guide

Bowman PETG	3M	Cardinal	Gerson	Kimberly Clark	McKesson
FP-007	8511				
FP-009			1730, 2735		
FP-010	9210				
FP-015				46767	
FP-021					
FP-022		AT54535, AT71035			
FP-028					91-1200, 91-1400, 91-1000
FP-038		AT7004, AT7511		47127, 48100	91-2002
FP-084		N95-ML, N95-S			
FP-119		AT7509			
FP-120		AT54635, AT71039, AT74631, AT74635, AT7511-WE		47147, 47500, 48247, 62114	91-2600, 91-1600
FP-121		AT70021, AT7004, AT71021, AT74531, AT771141, AT771211, AT7511		47080, 47095, 47107, 47117, 47127, 48100, 48201, 49310	91-2002
FP-122	8514			48220, 49215, 49235	
<b>Bowman Powder Coated</b>					
FB-001	8210				
FB-002	8511				
FB-003	8514				
FB-004					
FB-007					
FB-010				46767	
FB-021					91-2002
FB-037		AT7004, AT7511		47080, 47095, 47107, 47117, 47127, 48100, 48201, 49310	91-2002
FB-063					
FB-064		AT70021, AT7004, AT71021, AT7511, AT771211, AT74531, AT771141		47080, 47095, 47107, 47117, 47127, 48100, 48201, 49310	
FB-090		AT54635, AT71039, AT74631, AT74635, AT7511-WE		47147, 47500, 48247, 62114	91-2600, 91-1600
FB-091		AT51035, AT54535, AT71235, AT72835, AT73035, AT7505-P, AT752005, AT771145, AT74535		48220, 49215, 49235	



MediChoice	Medline	Moldex	Precept	Sperian	Tidi
	NON24506	2200N95, 1200, 2300N95, 2730	65-3395, 65-3395S		
	NON27110, NON27120, NON27374, NON27385, NON27377, NON27412EL		15100, 15101, 15130, 15155, 15160, 15200, 15211, 15212, 15240, 15260, 15300, 15320, 15500, 653320, 653322		
0205PG42073, 0205PG42121, 0205PG42333, 0205PG43092, 0205PG44073	NON27361A, NON27382, NON27408, NON27412				
	NON27122, NON27375, NON27378				9010, 9020, 9030, 9040
0205PG40220			65-3333		
	NON27381				
0205PG41573, 0205PG41592, 0205PG42592, 0205PG45033, 0205PG45073	NON27600		15310, 15330	14110452 One Fit W1400	
0205PG41001, 0205PG41010, 0205PG41092, 0205PG41201, 0205PG41331	NON27122, NON27375, NON27378				
		1200			
		2200N95, 2300N95, 2730			
				14110388 (N1105)	
	NON27374, NON27376, NON27385		15200, 15211, 15212, 15240, 15260, 15320, 653320, 653322		
	NON27122, NON27375, NON27378				9010, 9020, 9030, 9040
	NON27412				
0205PG41001, 0205PG41010, 0205PG41092, 0205PG41201, 0205PG41331	NON27122, NON27375, NON27378				
0205PG41573, 0205PG41592, 0205PG42592, 0205PG45033, 0205PG45073	NON27600		15310, 15330	14110452 One Fit W1400	
	NON27361A, NON27382, NON27408				



**Bulk Dispenser Types**

**Generic Bulk Bins**



**BP-021**  
Single bin

**BP-022**  
Double bin

**BP-023**  
Triple bin

**BP-090**  
Triple bin

**BP-012**  
Double bin

**BP-011**  
Single bin

Holds bouffant caps, shoe covers, beard restraints, gloves, etc. in bulk quantity

**Ear Protection**



**EC-065**

**EC-090**

Double and Triple compartment configurations with hinged lids

**Face Mask**



**FD-010**

**FD-005**

Hold one to three boxes of face masks in bulk quantity

**Apron/Gown**



**RP-011**

Holds flat pack gowns, coveralls, or aprons in bulk quantity

**RP-030**

Holds a box of thumbs-up gowns



**BP-012**  
Double Bulk Dispenser



**EP-105**  
Ear Protection Dispenser

## 27 Specialty Dispensers



### SURGICAL

#### SD-010

Two bins on top with a lid hold PPE in bulk quantity and coveralls or jumpsuits can be stored in the lower section

#### LP-004

Holds one box of face masks, three boxes of gloves, and has two bulk storage bins



### Face Mask Dispensers

### Bouffant Cap / Shoe Cover Dispensers



#### FP-400

Holds up to six boxes of face masks with adjustable dividers. Can accommodate face shield boxes as well. Shown with optional sign holders MP-035 (sold separately)



#### BB-001



#### BP-007

Exact Fit design dispensers for most name brand bouffant caps and shoe covers



**SAFETY  
AND INDUSTRIAL**



**CP-075**  
Holds up to 10 pairs of safety glasses with locking door

**BP-090**  
Holds earplugs, gloves, etc. in bulk quantity



All consumable items are for demonstration purposes only and not included with the dispensers.

**Bags on Demand**



**PS004-0212**  
Holds three boxes of gloves and a single roll of bags (up to 9" wide)



**BG001-0111**  
Holds a single roll of bags (up to 9" wide)



**BG002-0212**  
Holds two rolls of bags (up to 9" wide)

**Face Mask Dispensers**



**FB-002**



**FP-010**

Dispensers available for a variety of N-95 designs

## 29 Specialty Dispensers



### DENTAL

#### MD-100

Holds three boxes of gloves, two boxes of face masks, 1/4 fold towels and patient bibs in bulk quantity

#### MB-085

Holds one box of gloves and one box of face masks

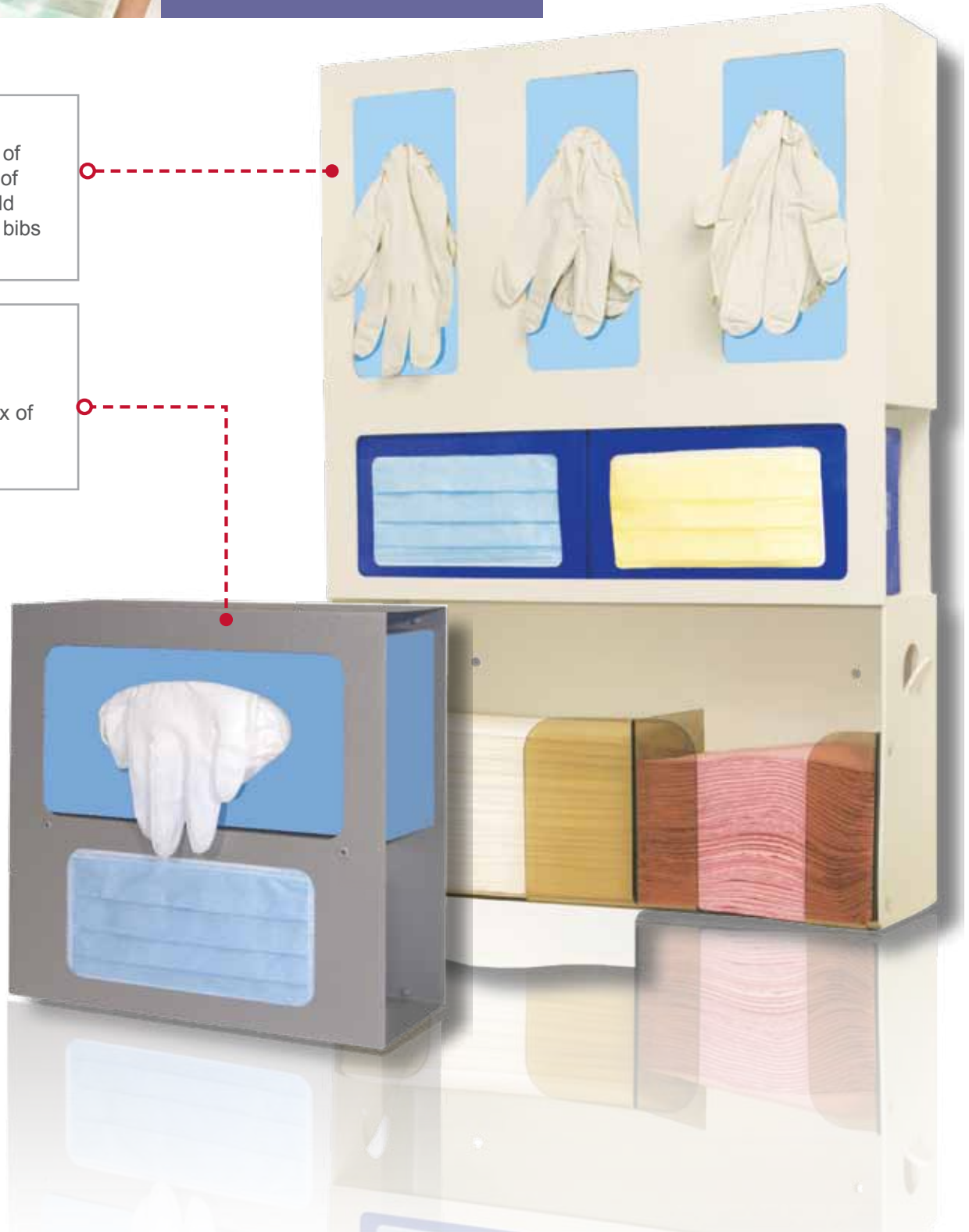



## EDUCATIONAL HEALTHCARE

Closed

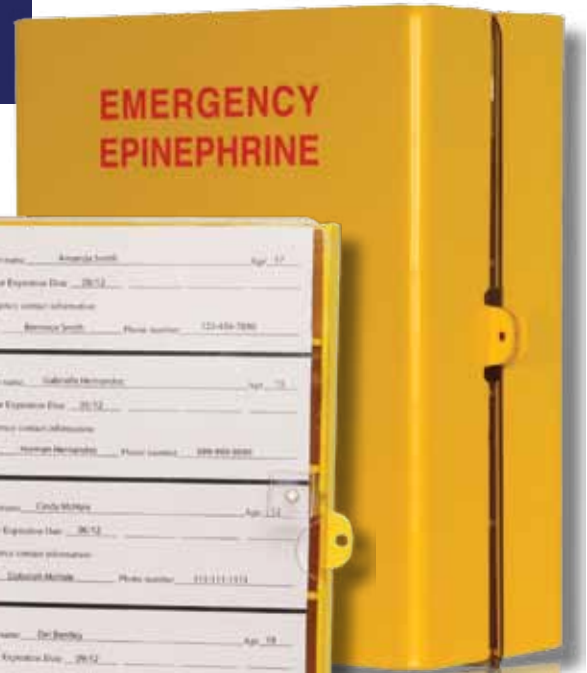

Open



### ED-760

- Holds up to ten epinephrine injector pens and opens up like a book
- Handle on the back enables easy transport
- Keyholes for wall mounting
- Tabs on front to add a lock
- Yellow Sintra plastic with clear PETG plastic divider for identification signage

All consumable items are for demonstration purposes only and not included with the dispensers.

## Infection Prevention Organizer

### ED-097

- Holds 1-2 boxes of facial tissue, a wet wipe dispenser, and a bottle of hand sanitizer
- Place in public areas to assist in your infection prevention efforts to prevent the spread of infections at ports of entry



## Protection Organizers and Accessories

Part Number	Image	Description	Units	W (L)	H	D	Weight	
LD-007		Protection Organizer Holds a variety of gowns, three boxes of gloves, and one box of face masks Protection organizer accessories available Quartz ABS plastic	IN	16 5/8	25 1/4	4 1/2	LB	3.85
			CM	42.2	64.1	11.4	KG	1.7
LD-037		Protection Organizer Holds a variety of gowns, two boxes of gloves, one box of face masks, and one box of face shields Protection organizer accessories available Quartz ABS plastic	IN	22 3/4	20 1/2	4 3/4	LB	4.25
			CM	57.8	52.1	12.0	KG	1.9
LD-040		Protection Organizer Holds a variety of gowns, one box of face masks, and one box of face shields Quartz ABS plastic and clear PETG plastic	IN	22 3/4	15	4 3/4	LB	3.50
			CM	57.8	38.1	12.0	KG	1.6
LD-062		Protection Organizer Holds a variety of gowns in two compartments, three boxes of gloves, two bulk face mask sections, and an additional shelf for medical supplies Protection organizer accessories available Quartz ABS plastic	IN	22 1/4	30 3/4	4	LB	6.20
			CM	56.5	78.1	10.2	KG	2.8
LD-063		Protection Organizer Holds a variety of gowns in two compartments, two boxes of gloves, and one box of face masks Protection organizer accessories available Quartz ABS plastic	IN	19 11/16	30	4 3/4	LB	5.30
			CM	50.0	76.1	12.1	KG	2.4
LD-064		Protection Organizer Holds a variety of gowns, three boxes of gloves, face masks in bulk, and contains a built-in storage caddy Protection organizer accessories available Quartz ABS plastic	IN	16 3/4	25 5/8	4	LB	3.70
			CM	42.5	65.1	10.2	KG	1.7
LD-067		Protection Organizer Holds laundered gowns, two boxes of gloves, and one box of face masks Protection organizer accessories available Quartz ABS plastic	IN	19 11/16	28 5/8	4 3/4	LB	5.40
			CM	50.0	72.7	12.1	KG	2.4
LD-070		Protection Organizer Holds a variety of gowns, three boxes of gloves, one box of face masks, and one box of face shields Protection organizer accessories available Quartz ABS plastic	IN	20 1/16	25 1/4	4 3/4	LB	4.30
			CM	50.9	64.1	12.1	KG	2.0
LP-004		Protection Organizer Holds bulk quantity protective apparel in two separate bins, three boxes of gloves, and one box of face masks Quartz ABS and clear PETG plastic	IN	22 1/8	19 11/16	4 7/8	LB	4.75
			CM	56.3	50.0	12.4	KG	2.2



## Protection Organizers and Accessories

Part Number	Image	Description	Units	W (L)	H	D	Weight	
PS002-0212		Protection Organizer Holds gowns in bulk, one box of face masks, and one box of face shields Keyholes for wall mounting Quartz ABS plastic	IN	15	22	4 1/2	LB	3.00
			CM	38.1	55.9	11.4	KG	1.4
PS003-0212		Protection Organizer Holds gowns in bulk, one box of face masks, and one box of face shields Keyholes for wall mounting Quartz ABS plastic	IN	15	22	4 1/2	LB	3.00
			CM	38.1	55.9	11.4	KG	1.4
PS005-0212		Protection Organizer Holds thumbs-up gowns in bulk quantity, two boxes of gloves, and face masks in bulk quantity with a built-in caddy for additional medical supplies Keyholes for wall mounting Quartz ABS plastic	IN	20 1/8	25 13/16	4	LB	4.90
			CM	51.1	65.5	10.2	KG	2.2
PS006-0512		Protection Organizer Holds a variety of gowns, two boxes of gloves, one box of face masks, and one box of face shields Protection organizer accessories available Quartz powder coated aluminum	IN	20 3/4	20 3/16	4 9/16	LB	5.00
			CM	52.7	51.3	11.6	KG	2.3
PS007-0212		Protection Organizer Holds a variety of gowns including thumbs-up gowns in bulk quantity, one box of face shields, and contains two built-in caddies to hold wet wipe and hand gel dispensers Keyholes for wall mounting Quartz ABS plastic	IN	20	20 15/16	4 15/16	LB	3.93
			CM	50.8	53.2	12.6	KG	1.8
GD-011		Glove Box Caddy - Single Holds a box of gloves Attaches to the bottom of protection organizer LD-037 Quartz ABS plastic	IN	10	4 1/8	5 5/8	LB	0.55
			CM	25.4	10.5	14.3	KG	0.2
GD-012		Glove Box Caddy - Double Holds two boxes of gloves Attaches to the bottom of protection organizer LD-037 Quartz ABS plastic	IN	22 5/8	5 5/8	4 1/8	LB	1.25
			CM	57.5	14.3	10.5	KG	0.6
GD-013		Glove Box Dispenser - Clip-On Holds a single box of gloves Clips onto the side of the protection organizers that are greater than 4" deep Quartz ABS plastic	IN	6	9 7/8	4	LB	0.65
			CM	15.2	25.0	10.1	KG	0.3
GD-111		Glove Box Dispenser - Single with Shelf Holds one box of gloves with an additional shelf to hold medical supplies Attaches to the bottom of protection organizer LD-037 Quartz ABS plastic	IN	22 5/8	5 5/8	4 1/8	LB	1.25
			CM	57.5	14.3	10.5	KG	0.6
MB-450		Door Hanger for Fire Doors Holds protection organizers at adjustable heights to accommodate fire door hardware Attaches to the top of a fire door Quartz powder coated metal	IN	34	17 11/16	3 1/16	LB	2.50
			CM	86.4	44.9	7.8	KG	1.1

## Protection Organizers and Accessories

Part Number	Image	Description	Units	W (L)	H	D	Weight	
MB-500		Wall/Glass Hanger Holds Bowman protection organizers on a wall or on glass utilizing double-sided semi-permanent tape Quartz powder coated metal	IN	22	4 5/8	9/16	LB	0.95
			CM	55.9	11.7	1.4	KG	0.4
MB-510		Wall/Door Hanger Holds Bowman protection organizers on a wall or door Keyholes for mounting to wall or door Quartz powder coated metal	IN	5 1/2	2 5/8	9/16	LB	0.20
			CM	14.0	6.7	1.4	KG	0.1
MB-600		Door Hanger Holds Bowman protection organizers Top of hanger hooks over the top of a door Quartz powder coated metal	IN	5 1/2	12 1/8	2 1/2	LB	1.05
			CM	14.0	30.8	6.4	KG	0.5
MB-601		Door Hanger Holds Bowman protection organizers Top of hanger hooks over the top of a door Quartz powder coated metal	IN	5 1/2	19	2 1/2	LB	1.40
			CM	14.0	48.3	6.4	KG	0.6
MP-015		Caddy Dispenser - Clip On Holds wet wipe canisters in various sizes Clips to the side of Bowman protection organizers that are greater than 4" deep Clear PETG plastic	IN	6 3/16	7 5/16	6 5/8	LB	0.85
			CM	15.7	18.6	16.9	KG	0.4
MP-025		Sign Holder Holds signage and attaches with double-sided tape to Bowman protection organizers Clear PETG plastic	IN	8 1/2	5 11/16	3/8	LB	0.45
			CM	21.6	14.5	1.0	KG	0.2
MP-042		Caddy Dispenser - Clip-On Holds medical supplies Clips to the side of Bowman protection organizers that are greater than 4" deep Clear PETG plastic	IN	4 7/16	4 1/16	5 1/8	LB	0.45
			CM	11.3	10.3	13.1	KG	0.2
MP-045		Sign Holder Holds signage and attaches with double-sided tape to Bowman protection organizers Clear PETG plastic	IN	8 1/2	11 3/16	3/8	LB	0.85
			CM	21.6	28.4	1.0	KG	0.4
MP-047		Sign Holder - Clip-On Holds signage and clips onto the front of Bowman protection organizers Clear PETG plastic	IN	8 1/2	11 3/16	5/8	LB	0.90
			CM	21.6	28.4	1.6	KG	0.4
MP-085		Caddy Dispenser - Clip-On Holds medical supplies Clips to the side of Bowman protection organizers that are greater than 4" deep Clear PETG plastic	IN	4 13/16	8 1/8	5 1/16	LB	0.90
			CM	12.2	20.6	12.8	KG	0.4

## Respiratory Hygiene Stations, Kiosk Stands, and Accessories

Part Number	Image	Description	Units	W (L)	H	D	Weight
FD-062		Respiratory Hygiene Station - Locking Holds two boxes of face masks, 1-2 boxes of facial tissues, and one hand sanitizer bottle Station has a hinged locking lid, and a locking adjustable lid to secure the hand sanitizer bottle Optional sign holders MP-070 or MP-075 (sold separately) Optional kiosk stand KS010 (sold separately) Keyholes for wall mounting Quartz ABS plastic and clear PETG plastic lid	IN	17 1/2	10	5	LB 2.80
			CM	44.5	25.4	12.7	KG 1.3
FD-111		Respiratory Hygiene Station - Non-locking Holds two boxes of face masks, 1-2 boxes of facial tissues, and one hand sanitizer pump or foam dispenser (sold separately) Optional sign holders MP-070 or MP-075 (sold separately) Optional kiosk stand KS010 (sold separately) Keyholes for wall mounting Quartz ABS plastic	IN	19 3/4	13 7/8	5	LB 1.85
			CM	50.2	35.3	12.7	KG 0.8
FD-112		Respiratory Hygiene Station - Locking Holds two boxes of face masks, 1-2 boxes of facial tissues, and one hand sanitizer pump or foam dispenser (sold separately) Station has a hinged locking lid Optional sign holders MP-070 or MP-075 (sold separately) Optional kiosk stand KS010 (sold separately) Keyholes for wall mounting Quartz ABS plastic with clear PETG plastic lid	IN	19 3/4	13 7/8	5 7/16	LB 2.70
			CM	50.2	35.3	13.8	KG 1.2
FP-058		Respiratory Hygiene Station - Non-locking Holds two boxes of face masks, 1-2 boxes of facial tissues, and one hand sanitizer bottle Optional sign holders MP-070 or MP-075 (sold separately) Optional kiosk stand KS010 (sold separately) Keyholes for wall mounting Clear PETG plastic	IN	17	9 7/8	4 9/16	LB 1.95
			CM	43.2	25.1	11.6	KG 0.9
RS001-0212		Respiratory Hygiene Station Holds two boxes of face masks, facial tissue, and either a hand gel dispenser bottle or a wet wipes container Optional sign holders MP-070 or MP-075 (sold separately) Optional kiosk stand KS010 (sold separately) Keyholes for wall mounting Quartz ABS plastic	IN	17 7/8	10 1/2	4 7/16	LB 1.70
			CM	45.5	26.7	11.3	KG 0.8
KS010-0412		Kiosk Stand Accommodates a variety of Bowman respiratory hygiene stations Quartz powder coated metal	IN	18	36 1/16	18	LB 6.20/ 9.80
			CM	45.7	91.6	45.7	KG 2.8/ 4.4
MP-070		Sign Holder Holds 8 1/2" x 11" signage vertically Hardware included for mounting to Bowman respiratory hygiene stations Clear PETG plastic	IN	8 5/8	13 13/16	5/16	LB 1.1
			CM	21.9	35.0	.8	KG 0.5
MP-075		Sign Holder Holds 11" x 8 1/2" signage horizontally Hardware included for mounting to Bowman respiratory hygiene stations Clear PETG plastic	IN	11 1/4	11 5/16	5/16	LB 1.15
			CM	28.6	28.7	.8	KG 0.5

## Glove Dispensers

Part Number	Image	Description	Units	W (L)	H	D	Weight	
GB-001		Glove Box Dispenser - Single with Adjustable Spring Holds one box of gloves Two-way keyholes for wall mounting White powder coated metal	IN	5 5/8	9 15/16	3 13/16	LB	1.4
			CM	14.2	25.3	9.7	KG	0.6
GB-002		Glove Box Dispenser - Double Holds two boxes of gloves Two-way keyholes for wall mounting White powder coated metal	IN	10 9/16	10	3 13/16	LB	1.6
			CM	26.8	25.5	9.7	KG	0.7
GB-003		Glove Box Dispenser - Triple Holds three boxes of gloves Two-way keyholes for wall mounting White powder coated metal	IN	15 13/16	10	3 13/16	LB	1.75
			CM	40.2	25.5	9.7	KG	0.8
GB-012		Glove Box Dispenser - Expandable Holds one or two boxes of gloves horizontally Keyholes for wall mounting White powder coated metal	IN	5 1/4	8 13/16	4 3/8	LB	2.00
			CM	13.3	22.4	11.0	KG	0.9
GB-027		Glove Box Dispenser Holds one box of food service poly gloves Keyholes for wall mounting White powder coated metal	IN	7 11/16	6 5/16	15/16	LB	0.65
			CM	19.6	16.0	2.3	KG	0.3
GB-059		Glove Box Dispenser - Quad Holds four boxes of gloves Two-way keyholes for wall mounting White powder coated metal	IN	22 5/16	10	3 13/16	LB	2.65
			CM	56.7	25.4	9.7	KG	1.2
GB-067		Glove Box Dispenser - Double - Space Saver Holds two boxes of gloves that fit end to end Two-way keyholes for wall mounting either horizontally or vertically White powder coated metal	IN	5 5/8	20 1/16	3 15/16	LB	2.40
			CM	14.2	50.9	10.0	KG	1.1
GB-068		Glove Box Dispenser - Triple - Space Saver Holds three boxes of gloves that fit end to end Two-way keyholes for wall mounting either horizontally or vertically White powder coated metal	IN	5 1/2	30 1/16	3 15/16	LB	3.50
			CM	14.0	76.3	10.0	KG	1.6
GB-074		Glove Box Dispenser - Single - Large Capacity with Adjustable Spring Holds one box of gloves Two-way keyholes for wall mounting White powder coated metal	IN	6 1/2	9 15/16	3 13/16	LB	1.55
			CM	16.5	25.3	9.7	KG	0.7
GB-144		Glove Box Dispenser - Single with Adjustable Spring Holds one box of gloves Front screw holes for mounting inside a cabinet White powder coated metal	IN	5 5/8	10	3 13/16	LB	1.35
			CM	14.2	25.4	9.7	KG	0.6

## Glove Dispensers

Part Number	Image	Description	Units	W (L)	H	D	Weight	
GC-009		Glove Dispenser - Bulk Holds gloves in bulk quantity in single compartment with a hinged lid Keyholes for wall mounting White Sintra plastic	IN	5 1/16	11 3/16	4 7/16	LB	0.60
			CM	12.8	28.5	11.3	KG	0.3
GC-016		Glove Box Dispenser - Single with Adjustable Spring Holds one box of gloves Two-way keyholes for wall mounting Beige Sintra plastic	IN	5 13/16	10 1/16	4 1/16	LB	0.45
			CM	14.7	25.6	10.3	KG	0.2
GC-018		Glove Box Dispenser - Single with Adjustable Spring Holds one box of gloves Two-way keyholes for wall mounting White Sintra plastic	IN	5 13/16	10 1/16	4 1/16	LB	0.45
			CM	14.7	25.6	10.3	KG	0.2
GC-019		Glove Box Dispenser - Single with Adjustable Spring Holds one box of gloves Two-way keyholes for wall mounting Blue Sintra plastic	IN	5 13/16	10 1/16	4 1/16	LB	0.45
			CM	14.7	25.6	10.3	KG	0.2
GD-042		Glove Box Dispenser - Double with Divider Holds two boxes of gloves Three-way keyholes for wall mounting Quartz ABS plastic	IN	11 3/8	9 15/16	3 3/4	LB	0.90
			CM	28.9	25.2	9.5	KG	0.4
GD-043		Glove Box Dispenser - Triple with Dividers Holds three boxes of gloves Three-way keyholes for wall mounting Quartz ABS plastic	IN	17	9 15/16	3 3/4	LB	1.30
			CM	43.2	25.2	9.5	KG	0.6
GL042-0212		Glove Box Dispenser - Quad with Shelf Holds four boxes of gloves Shelf on top to hold additional supplies Keyholes for wall mounting Quartz ABS plastic	IN	20 1/8	12 5/16	3 15/16	LB	2.20
			CM	51.1	31.2	10.0	KG	1.0
GP-013		Glove Box Dispenser - Single with Adjustable Spring Holds one box of gloves Two-way keyholes for wall mounting Clear PETG plastic	IN	5 11/16	9 7/8	3 15/16	LB	0.70
			CM	14.5	25.0	10.0	KG	0.3
GP-014		Glove Box Dispenser - Double Holds two boxes of gloves Two-way keyholes for wall mounting Clear PETG plastic	IN	10 11/16	10 1/8	3 15/16	LB	0.85
			CM	27.2	25.7	10.0	KG	0.4

## Glove Dispensers

Part Number	Image	Description	Units	W (L)	H	D	Weight	
GP-015		Glove Box Dispenser - Triple Holds three boxes of gloves Two-way keyholes for wall mounting Clear PETG plastic	IN	15 15/16	10 1/8	3 15/16	LB	0.95
			CM	40.5	25.7	10.0	KG	0.4
GP-020		Glove Box Dispenser - Single - Large Capacity with Adjustable Spring Holds one box of gloves Two-way keyholes for wall mounting Clear PETG plastic	IN	6 5/8	10	4	LB	0.85
			CM	16.9	25.5	10.2	KG	0.4
GP-025		Glove Box Dispenser Holds one box of food service poly gloves Keyholes for wall mounting Clear PETG plastic	IN	8 5/16	7	1 1/8	LB	0.40
			CM	21.1	17.8	2.9	KG	0.2
GP-042		Glove Box Dispenser - Double with Divider Holds two boxes of gloves Three-way keyholes for wall mounting Clear PETG plastic	IN	11 5/16	9 7/8	3 11/16	LB	1.35
			CM	28.7	25.1	9.4	KG	0.6
GP-043		Glove Box Dispenser - Triple with Dividers Holds three boxes of gloves Three-way keyholes for wall mounting Clear PETG plastic	IN	16 7/8	9 7/8	3 11/16	LB	1.60
			CM	42.9	25.1	9.4	KG	0.7
GP-061		Glove Box Dispenser - Quad Holds four boxes of gloves Two-way keyholes for wall mounting Clear PETG plastic	IN	22 7/16	10	3 7/8	LB	1.15
			CM	57.0	25.5	9.9	KG	0.5
GP-071		Glove Box Dispenser - Single - Narrow Holds one thin box of gloves Three-way keyholes for wall mounting Clear PETG plastic	IN	5 11/16	9 7/8	2 15/16	LB	0.65
			CM	14.5	25.0	7.5	KG	0.3
GP-072		Glove Box Dispenser - Double - Narrow Holds two thin boxes of gloves Three-way keyholes for wall mounting Clear PETG plastic	IN	10 11/16	10 1/8	2 15/16	LB	0.75
			CM	27.2	25.7	7.5	KG	0.3
GP-073		Glove Box Dispenser - Triple - Narrow Holds three thin boxes of gloves Three-way keyholes for wall mounting Clear PETG plastic	IN	15 15/16	10 1/8	2 15/16	LB	0.85
			CM	40.5	25.7	7.5	KG	0.4

## Glove Dispensers







Part Number	Image	Description	Units	W (L)	H	D	Weight	
GP-085		Glove Package Dispenser with Adjustable Divider Holds a variety of sterile surgical glove packages with adjustable divider Vertically mounts on the wall with keyholes Clear PETG plastic	IN	8 3/16	11 11/16	6 3/16	LB	2.00
			CM	20.8	29.7	15.7	KG	0.9
GP-106		Glove Box Dispenser - Double - Space Saver Holds two boxes of gloves that fit end to end Two-way keyholes for wall mounting either horizontally or vertically Clear PETG plastic	IN	5 11/16	20 1/8	4 1/16	LB	1.35
			CM	14.5	51.1	10.4	KG	0.6
GP-107		Glove Box Dispenser - Triple - Space Saver Holds three boxes of gloves that fit end to end Two-way keyholes for wall mounting either horizontally or vertically Clear PETG plastic	IN	5 1/2	30 1/8	3 15/16	LB	1.95
			CM	14.0	76.5	10.0	KG	0.9
GP-120		Glove Box Dispenser - Single Holds one box of gloves Keyholes for wall mounting Clear PETG plastic	IN	10 7/16	10 3/4	4 7/16	LB	1.05
			CM	26.5	27.3	11.3	KG	0.5
GP-310		Glove Box Dispenser - Single Holds one box of gloves horizontally Keyholes for wall mounting Clear PETG plastic	IN	11 3/16	4 7/8	3 11/16	LB	0.65
			CM	28.4	12.3	9.4	KG	0.3
GP-320		Glove Box Dispenser - Double Holds two boxes of gloves which stack horizontally Keyholes for wall mounting Clear PETG plastic	IN	11 3/16	9 5/8	3 11/16	LB	1.20
			CM	28.4	24.4	9.4	KG	0.5
GP-330		Glove Box Dispenser - Triple Holds three boxes of gloves which stack horizontally Keyholes for wall mounting Clear PETG plastic	IN	11 3/16	14 3/8	3 11/16	LB	1.65
			CM	28.4	36.4	9.4	KG	0.7
GP-340		Glove Box Dispenser - Quad Holds four boxes of gloves which stack horizontally Keyholes for wall mounting Clear PETG plastic	IN	11 3/16	19 1/8	3 11/16	LB	2.25
			CM	28.4	48.5	9.4	KG	1.0
GS-004		Glove Box Dispenser - Single with Adjustable Spring Holds one box of gloves Two-way keyholes for wall mounting Stainless Steel	IN	5 5/8	9 15/16	3 13/16	LB	1.35
			CM	14.2	25.3	9.7	KG	0.6
GS-005		Glove Box Dispenser - Double Holds two boxes of gloves Two-way keyholes for wall mounting Stainless Steel	IN	10 9/16	10 1/16	3 13/16	LB	1.40
			CM	26.8	25.5	9.7	KG	0.6

## Glove Dispensers



Part Number	Image	Description	Units	W (L)	H	D	Weight	
GS-006		Glove Box Dispenser - Triple Holds three boxes of gloves Two-way keyholes for wall mounting Stainless Steel	IN	15 13/16	10 1/16	3 13/16	LB	1.80
			CM	40.2	25.5	9.6	KG	0.8
GS-026		Glove Box Dispenser Holds one box of food service poly gloves Keyholes for wall mounting Stainless Steel	IN	7 11/16	6 5/16	15/16	LB	0.65
			CM	19.6	16.0	2.3	KG	0.3
GS-060		Glove Box Dispenser - Quad Holds four boxes of gloves Two-way keyholes for wall mounting Stainless Steel	IN	22 5/16	10	3 13/16	LB	2.35
			CM	56.7	25.4	9.7	KG	1.1
GS-073		Glove Box Dispenser - Single - Large Capacity with Adjustable Spring Holds one box of gloves Two-way keyholes for wall mounting Stainless Steel	IN	6 1/2	9 15/16	3 13/16	LB	1.50
			CM	16.5	25.3	9.7	KG	0.7
GS-108		Glove Box Dispenser - Double - Space Saver Holds two boxes of gloves that fit end to end Two-way keyholes for wall mounting either horizontally or vertically Stainless Steel	IN	5 5/8	20	3 15/16	LB	2.35
			CM	14.2	50.9	10.0	KG	1.1
GS-109		Glove Box Dispenser - Triple - Space Saver Holds three boxes of gloves that fit end to end Two-way keyholes for wall mounting either horizontally or vertically Stainless Steel	IN	5 1/2	30 1/16	3 15/16	LB	3.55
			CM	14.0	76.3	10.0	KG	1.6
GS-122		Glove Box Dispenser - Double with Divider Holds two boxes of gloves Two-way keyholes for wall mounting Stainless Steel	IN	10 9/16	10	3 13/16	LB	1.75
			CM	26.9	25.5	9.7	KG	0.8
GS-123		Glove Box Dispenser - Triple with Dividers Holds three boxes of gloves Two-way keyholes for wall mounting Stainless Steel	IN	15 7/8	10	3 13/16	LB	2.25
			CM	40.3	25.5	9.7	KG	1.0
GS-124		Glove Box Dispenser - Quad with Dividers Holds four boxes of gloves Two-way keyholes for wall mounting Stainless Steel	IN	21 3/16	10	3 13/16	LB	2.40
			CM	53.7	25.5	9.7	KG	1.1
GS-133		Glove Box Dispenser - Triple with Dividers & Saniguard™ Holds three boxes of gloves Two-way keyholes for wall mounting Stainless steel with Saniguard™ Antimicrobial clear powder coating	IN	15 7/8	10	3 13/16	LB	2.25
			CM	40.3	25.5	9.7	KG	1.0
GW-029		Glove Box Dispenser - Single Holds one box of gloves Screw holes for wall mounting Coated wire	IN	11 7/16	4 1/8	4 3/16	LB	0.75
			CM	29.1	10.5	10.7	KG	0.3



## Glove Dispensers

Part Number	Image	Description	Units	W (L)	H	D	Weight	
GW-040		Glove Box Dispenser - Double Holds two boxes of gloves horizontally Screw holes for wall mounting Coated wire	IN	11 5/8	11 9/16	3 15/16	LB	1.00
			CM	29.5	29.4	10.0	KG	0.5
GW-045		Glove Box Dispenser - Double Holds two boxes of gloves vertically Screw holes for wall mounting Coated wire	IN	11 1/2	7 13/16	4 1/8	LB	0.95
			CM	29.2	19.8	10.4	KG	0.4
GW-050		Glove Box Dispenser - Triple Holds three boxes of gloves horizontally Screw holes for wall mounting Coated wire	IN	14 1/4	11 5/8	9 9/16	LB	1.52
			CM	36.2	29.5	24.2	KG	0.7
GW-055		Glove Box Dispenser - Triple Holds three boxes of gloves vertically Screw holes for wall mounting Coated wire	IN	16 1/2	8	4 1/8	LB	1.25
			CM	41.9	20.3	10.4	KG	0.6
GW-060		Glove Box Dispenser - Quad Holds four boxes of gloves horizontally Screw holes for wall mounting Coated wire	IN	22 5/8	11 5/8	3 15/16	LB	2.10
			CM	57.5	29.5	9.9	KG	1.0
GW-065		Glove Box Dispenser - Quad Holds four boxes of gloves vertically Screw holes for wall mounting Coated wire	IN	22 1/2	8	4 1/8	LB	1.63
			CM	57.2	20.3	10.4	KG	0.7

## Mask Dispensers

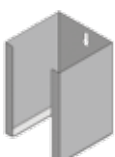
FB-001		Face Mask Dispenser Holds one box of face masks Keyholes for wall mounting White powder coated metal	IN	5 11/16	6 7/16	5 1/16	LB	1.00
			CM	14.5	16.3	12.9	KG	0.5
FB-002		Face Mask Dispenser Holds one box of face masks Keyholes for wall mounting White powder coated metal	IN	6 7/16	8 1/2	5 3/16	LB	1.35
			CM	16.4	21.7	13.1	KG	0.6
FB-003		Face Mask Dispenser Holds one box of face masks Keyholes for wall mounting White powder coated metal	IN	8 1/16	9	5 3/16	LB	1.65
			CM	20.5	22.9	13.2	KG	0.7
FB-004		Face Mask Dispenser Holds one box of face masks Keyholes for wall mounting White powder coated metal	IN	5 5/16	7 3/4	5 5/16	LB	0.50
			CM	13.5	19.8	13.5	KG	0.2

# 41 Product Index

## Mask Dispensers



Part Number	Image	Description	Units	W (L)	H	D	Weight	
FB-005		Face Mask Dispenser Holds one box of face masks Keyholes for wall mounting White powder coated metal	IN	9 9/16	7 3/16	3 9/16	LB	0.28
			CM	24.3	18.2	9.0	KG	0.1
FB-010		Face Mask Dispenser Holds one box of face masks Keyholes for wall mounting White powder coated metal	IN	10 7/16	4 1/8	4 13/16	LB	0.70
			CM	26.5	10.5	12.2	KG	0.3
FB-021		Face Mask Dispenser Holds one box of face masks Keyholes for wall mounting White powder coated metal	IN	7 7/16	4 3/4	4 13/16	LB	0.85
			CM	18.9	12.1	12.2	KG	0.4
FB-037		Face Mask Dispenser Holds one box of face masks Keyholes for wall mounting White powder coated metal	IN	7 9/16	4 1/4	4 1/8	LB	0.65
			CM	19.2	10.8	10.5	KG	0.3
FB-039		Face Mask Dispenser Holds one box of face masks Keyholes for wall mounting White powder coated metal	IN	7 13/16	7 1/2	5 1/4	LB	1.52
			CM	19.8	19.1	13.3	KG	0.7
FB-040		Face Mask Dispenser Holds one box of face masks Keyholes for wall mounting White powder coated metal	IN	8	6	5 1/4	LB	1.30
			CM	20.3	15.2	13.3	KG	0.6
FB-041		Face Mask Dispenser - Bulk Holds face masks in bulk quantity Keyholes for wall mounting White powder coated metal	IN	8 1/2	5	3 1/4	LB	0.95
			CM	21.6	12.6	8.3	KG	0.4
FB-063		Face Mask Dispenser Holds one box of face masks Keyholes for wall mounting White powder coated metal	IN	7 13/16	7 1/2	5 1/4	LB	1.35
			CM	19.8	19.1	13.3	KG	0.6
FB-064		Face Mask Dispenser Holds one box of face masks Keyholes for wall mounting White powder coated metal	IN	7 9/16	4 1/4	4 1/8	LB	0.75
			CM	19.2	10.8	10.5	KG	0.3
FB-090		Face Mask Dispenser Holds one box of face masks or face shields Keyholes for wall mounting White powder coated metal	IN	9 1/16	7 1/2	4 1/16	LB	1.20
			CM	23.0	19.1	10.3	KG	0.5
FB-091		Face Mask Dispenser Holds one box of face masks Keyholes for wall mounting White powder coated metal	IN	7 7/8	7 11/16	5	LB	1.30
			CM	20.1	19.6	12.7	KG	0.6

## Mask Dispensers

Part Number	Image	Description	Units	W (L)	H	D	Weight	
FP-007		Face Mask Dispenser Holds one box of face masks Keyholes for wall mounting Clear PETG plastic	IN	6 9/16	8 1/2	5 5/16	LB	0.75
			CM	16.7	21.7	13.5	KG	0.3
FP-009		Face Mask Dispenser Holds one box of face masks Keyholes for wall mounting Clear PETG plastic	IN	5 1/2	7 3/4	5 1/2	LB	0.60
			CM	14.0	19.8	14.0	KG	0.3
FP-010		Face Mask Dispenser Holds one box of face masks Keyholes for wall mounting Clear PETG plastic	IN	9 11/16	7 3/16	3 11/16	LB	0.65
			CM	24.6	18.2	9.4	KG	0.3
FP-015		Face Mask Dispenser Holds one box of face masks Keyholes for wall mounting Clear PETG plastic	IN	10 9/16	4 1/8	4 15/16	LB	0.40
			CM	26.9	10.5	12.6	KG	0.2
FP-021		Face Mask Dispenser Holds one box of face masks Keyholes for wall mounting Clear PETG plastic	IN	7 15/16	4 1/4	5 3/16	LB	0.45
			CM	20.2	10.7	13.2	KG	0.2
FP-022		Face Mask Dispenser Holds one box of face masks Keyholes for wall mounting Clear PETG plastic	IN	8 1/8	7 3/4	4 15/16	LB	0.90
			CM	20.6	19.6	12.5	KG	0.4
FP-028		Face Mask Dispenser Holds one box of face masks Keyholes for wall mounting Clear PETG plastic	IN	7 11/16	5 5/8	5 3/16	LB	0.55
			CM	19.6	14.2	13.2	KG	0.2
FP-038		Face Mask Dispenser Holds one box of cone face masks Keyholes for wall mounting Clear PETG plastic	IN	7 11/16	4 5/16	4 1/4	LB	0.40
			CM	19.6	11.0	10.8	KG	0.2
FP-084		Face Mask Dispenser Holds one box of cone face masks Keyholes for wall mounting Clear PETG plastic	IN	5 3/16	6 1/8	5 5/16	LB	0.50
			CM	13.1	15.5	13.5	KG	0.2
FP-119		Face Mask Dispenser Holds one box of cone face masks Keyholes for wall mounting Clear PETG plastic	IN	4 11/16	6 1/2	4 11/16	LB	0.55
			CM	11.9	16.5	11.9	KG	0.2
FP-120		Face Mask Dispenser Holds one box of face masks or face shields Keyholes for wall mounting Clear PETG plastic	IN	9 3/16	7 1/2	4 3/16	LB	0.70
			CM	23.4	19.1	10.7	KG	0.3

All consumable items are for demonstration purposes only and not included with the dispensers.







## Mask Dispensers

Part Number	Image	Description	Units	W (L)	H	D	Weight	
FP-121		Face Mask Dispenser Holds one box of face masks Keyholes for wall mounting Clear PETG plastic	IN	7 11/16	4 3/8	4 1/8	LB	0.45
			CM	19.6	11.0	10.5	KG	0.2
FP-122		Face Mask Dispenser Holds one box of face masks Keyholes for wall mounting Clear PETG plastic	IN	8 1/16	7 5/8	5 3/8	LB	0.75
			CM	20.5	19.3	13.7	KG	0.3



## Bulk Dispensers

BP-011		Bulk Dispenser - Tall Single Bin Holds a variety of protective apparel in bulk Single compartment with a hinged lid Keyholes for wall mounting Clear PETG plastic	IN	12 1/4	16 15/16	5 5/8	LB	3.10
			CM	31.2	43.1	14.2	KG	1.4
BP-012		Bulk Dispenser - Tall Double Bin Holds a variety of protective apparel in bulk Dual compartments with hinged lids Keyholes for wall mounting Clear PETG plastic	IN	12 1/4	17	5 5/8	LB	3.50
			CM	31.2	43.2	14.2	KG	1.6
BP-021		Bulk Dispenser - Single Bin Holds a variety of protective apparel in bulk Single compartment with a hinged lid Keyholes for wall mounting Clear PETG plastic	IN	12 1/4	11 1/8	5 5/8	LB	2.20
			CM	31.2	28.3	14.2	KG	1.0
BP-022		Bulk Dispenser - Double Bin Holds a variety of protective apparel in bulk Dual compartments with hinged lids Keyholes for wall mounting Clear PETG plastic	IN	12 1/4	11 1/8	5 5/8	LB	2.45
			CM	31.2	28.3	14.2	KG	1.1
BP-023		Bulk Dispenser - Triple Bin Holds a variety of protective apparel in bulk Triple compartments with hinged lids Keyholes for wall mounting Clear PETG plastic	IN	17 1/2	11 1/8	5 13/16	LB	3.50
			CM	44.5	28.3	14.8	KG	1.6
BP-090		Bulk Dispenser - Tall Triple Bin Holds a variety of protective apparel in bulk Triple compartments with hinged lids Keyholes for wall mounting Clear PETG plastic	IN	18 3/8	17 1/16	5 5/8	LB	5.00
			CM	46.7	43.4	14.2	KG	2.3
EC-065		Hearing Protection Dispenser - Double Bin Holds earplugs in bulk Dual compartments with a single hinged lid Keyholes for wall mounting White Sintra plastic with clear PETG plastic lid	IN	15 3/8	11 11/16	8 5/16	LB	2.20
			CM	39.1	29.7	21.1	KG	1.0
EC-090		Hearing Protection Dispenser - Triple Bin Holds earplugs in bulk Triple compartments with a single hinged lid Keyholes for wall mounting Blue Sintra plastic	IN	12 1/2	8 9/16	7 5/16	LB	1.45
			CM	31.8	21.7	18.5	KG	0.7

## Bulk Dispensers

Part Number	Image	Description	Units	W (L)	H	D	Weight
EP-105		Hearing Protection Dispenser - Single Bin Holds earplugs in bulk quantity Single compartment with a hinged lid Keyholes for wall mounting Clear PETG plastic	IN	9 1/4	11 9/16	6 3/4	LB 1.95
			CM	23.5	29.3	17.2	KG 0.9
FD-005		Face Mask Dispenser - Bulk with Hinged Lid Holds face masks in bulk quantity Keyholes for wall mounting White ABS and clear PETG plastic	IN	8 11/16	5	4 3/8	LB 0.95
			CM	22.0	12.6	11.1	KG 0.4
FD-010		Face Mask Dispenser - Bulk with Hinged Lid Holds face masks in bulk quantity Keyholes for wall mounting White ABS and clear PETG plastic	IN	8 11/16	9 3/4	4 3/8	LB 1.50
			CM	22.0	24.7	11.1	KG 0.7
FP-017		Face Mask Dispenser Holds cone face masks in bulk quantity with a hinged lid Keyholes for wall mounting Clear PETG plastic	IN	6 11/16	9	5 11/16	LB 1.40
			CM	17.0	22.8	14.5	KG 0.6
RP-011		Gown Dispenser Holds a variety of gowns in bulk Hinged lid with opening at bottom of unit Keyholes for wall mounting Clear PETG plastic face with white ABS back	IN	14 11/16	15 1/8	5 1/16	LB 3.10
			CM	37.3	38.4	12.8	KG 1.4
RP-012		Gown Dispenser - 4" Holds a variety of gowns in bulk Hinged lid with opening at bottom of unit Keyholes for wall mounting Clear PETG plastic face with white ABS back	IN	14 11/16	15 1/8	4	LB 2.95
			CM	37.3	38.4	10.2	KG 1.3
RP-013		Gown Dispenser Holds a variety of gowns in bulk Opening at bottom of unit Keyholes for wall mounting Clear PETG plastic face with white ABS back	IN	14 5/16	15	4 3/4	LB 3.00
			CM	36.4	38.2	12.0	KG 1.4

## Specialty Dispensers

BB-001		Bouffant Cap or Shoe Cover Dispenser Holds a box of bouffant caps or shoe covers Keyholes for wall mounting White powder coated metal	IN	11 1/4	11 3/16	5 1/8	LB 2.25
			CM	28.6	28.3	13.0	KG 1.02
BB-034		Bouffant Cap or Shoe Cover Dispenser Holds a box of bouffant caps or shoe covers Keyholes for wall mounting White powder coated metal	IN	10 1/16	10	5 5/16	LB 2.15
			CM	25.6	25.4	13.5	KG 1.0

## Specialty Dispensers

Part Number	Image	Description	Units	W (L)	H	D	Weight	
BG001-0111		Bag Dispenser Holds a single roll of bags (up to 9" long) Keyholes for wall mounting Clear PETG plastic	IN	10 1/8	3 5/8	3 15/16	LB	0.65
			CM	25.7	9.1	10.0	KG	0.3
BG001-0212		Bag Dispenser Holds a single roll of bags (up to 9" long) Keyholes for wall mounting Quartz ABS plastic	IN	10 1/8	3 5/8	3 15/16	LB	0.55
			CM	25.7	9.1	10.0	KG	0.2
BG002-0111		Bag Dispenser Holds two rolls of bags (up to 9" long) Keyholes for wall mounting Clear PETG plastic	IN	10 1/8	7 1/8	3 15/16	LB	1.15
			CM	25.7	18.0	10.0	KG	0.5
BG002-0212		Bag Dispenser Holds two rolls of bags (up to 9" long) Keyholes for wall mounting Quartz ABS plastic	IN	10 1/8	7 1/8	3 15/16	LB	0.95
			CM	25.7	18.0	10.0	KG	0.4
BG003-0111		Bag Dispenser Holds a box of SPATS™ Bags Keyholes for wall mounting Clear PETG plastic	IN	5 11/16	10 11/16	2 15/16	LB	0.65
			CM	14.5	27.1	7.5	KG	0.3
BG004-0111		Bag Dispenser Holds a box of SPATS™ Bags Keyholes for wall mounting Clear PETG plastic	IN	5 15/16	9 7/16	3 15/16	LB	.67
			CM	15.1	23.9	10.0	KG	0.3
BP-001		Beard Restraint Dispenser Bulk container for beard restraints Keyholes for wall mounting Clear PETG plastic	IN	11 1/2	11 5/8	5 1/4	LB	2.15
			CM	29.2	29.5	13.3	KG	1.0
BP-007		Bouffant Cap or Shoe Cover Dispenser Holds a box of bouffant caps or shoe covers Keyholes for wall mounting Clear PETG plastic	IN	11 3/8	11 1/4	5 1/4	LB	0.95
			CM	28.9	28.5	13.4	KG	0.4
CP-071		Eyewear Dispenser - Open Top Holds up to ten pairs of safety glasses Keyholes for wall mounting Clear PETG plastic	IN	9 1/16	4 3/4	6 11/16	LB	0.80
			CM	23.1	12.1	17.0	KG	0.4
CP-072		Eyewear Dispenser - Hinged Lid Top Holds up to six pairs of safety glasses Keyholes for wall mounting Clear PETG plastic	IN	9 1/4	3 7/16	6 11/16	LB	1.05
			CM	23.5	8.8	17.0	KG	0.5
CP-073		Eyewear Dispenser - Hinged Lid Top Holds ten or more pairs of safety glasses Keyholes for wall mounting Clear PETG plastic	IN	9 1/4	5 11/16	9 5/16	LB	2.25
			CM	23.5	14.5	23.7	KG	1.0

## Specialty Dispensers

Part Number	Image	Description	Units	W (L)	H	D	Weight	
CP-075		Eyewear Cabinet - Locking Holds up to ten pairs of safety glasses Keyholes for wall mounting White ABS plastic with clear PETG plastic locking door	IN	13 1/2	20	4 1/8	LB	4.25
			CM	34.3	50.8	10.5	KG	1.9
CP-076		Eyewear Cabinet - Locking Holds up to 12 pairs of safety glasses on nose holders Additional space at bottom of cabinet for safety glass storage Keyholes for wall mounting White ABS plastic with clear PETG plastic locking door	IN	20	20	5	LB	6.35
			CM	50.8	50.8	12.7	KG	2.9
CP-831		Eyeglass Cleaning Wipes Dispenser Holds one box of eyeglass cleaning wipes Keyholes for wall mounting Clear PETG plastic	IN	18	22 1/2	8	LB	0.45
			CM	45.7	57.2	20.3	KG	0.2
ED-097		Infection Prevention Organizer Holds 1-2 boxes of facial tissue, one hand sanitizer bottle, and may accommodate a variety of sizes of wet wipe dispensers 11" x 8 1/2" sign holder (MP-075) included with unit Keyholes for wall mounting Optional kiosk stand KS010 (sold separately) Quartz ABS plastic and clear PETG sign holder	IN	15	11 3/8	5 3/4	LB	1.8
			CM	38.1	28.9	14.6	KG	0.8
ED-750		Epinephrine Injector Dispenser Holds up to 5 Epinephrine Injectors Dual-sided clear PETG plastic door sleeve for identification signage Keyholes for wall mounting Quartz ABS and Clear PETG plastic door	IN	9	11 3/16	2 1/2	LB	1.85
			CM	22.9	28.4	6.4	KG	.8
ED-760		Epinephrine Injector Dispenser Holds up to 10 Epinephrine Injectors and opens up like a book Dual-sided clear PETG plastic divider for identification signage Handle on the back enables easy transport Tabs on front for lock placement Keyholes for wall mounting Yellow Sintra and clear PETG plastic	IN	9 1/2	11	4 5/8	LB	2.40
			CM	24.1	27.9	11.8	KG	1.1
FD-068		Infection Prevention Organizer Holds two boxes of gloves, one box of face masks, and one hand sanitizer bottle Optional kiosk stand KS010 (sold separately) Keyholes for wall mounting Quartz ABS plastic	IN	18 1/2	11 5/8	4 1/2	LB	2.05
			CM	47.0	29.5	11.4	KG	0.9
FP-400		Surgical Face Mask Dispenser Holds up to six boxes of face masks with adjustable dividers Optional sign holders MP-035 (shown) attach to top of unit (sold separately) White ABS and clear PETG plastic	IN	27 1/2	11 13/16	9 13/16	LB	8.85
			CM	69.9	30.0	25.0	KG	4.0
HP-010		Hairnet Dispenser Holds individual hairnet packages in bulk quantity Keyholes for wall mounting or sits on the counter Clear PETG plastic	IN	4 7/16	8	3 15/16	LB	0.65
			CM	11.3	20.3	10.0	KG	0.3
KP-143		Clipper Blade Dispenser Holds individual 3M clipper blade packets in bulk Keyholes for wall mounting or can sit on the counter Clear PETG plastic	IN	2 7/8	10 1/8	2 1/16	LB	0.35
			CM	7.2	25.7	5.3	KG	0.2

## Specialty Dispensers







Part Number	Image	Description	Units	W (L)	H	D	Weight	
LB001-0111		Bio Shield - Large May be used as a splash guard during phlebotomy procedures Clear PETG plastic	IN	11 1/2	15	7 1/2	LB	1.20
			CM	29.2	38.1	19.1	KG	0.5
LB002-0111		Bio Shield - Small May be used as a splash guard during phlebotomy procedures Clear PETG plastic	IN	8	9	5	LB	0.55
			CM	20.3	22.9	12.7	KG	0.2
MA-205		Shelf Holds documents or medical supplies on a pull-up shelf Holes for wall/door mounting White powder coated aluminum	IN	11 1/4	7 9/16	15 1/8	LB	2.75
			CM	28.6	19.2	38.5	KG	1.2
MB-085		Dental Organizer Holds one box of gloves and one box of face masks Keyholes for wall mounting Bronze powder coated metal	IN	9 7/8	10 1/8	4 3/16	LB	2.60
			CM	25.0	25.7	10.6	KG	1.2
MB-095		Dental Organizer Holds one box of gloves, one box of face masks, and bulk towels or aprons Keyholes for wall mounting White powder coated metal	IN	9 15/16	17 9/16	4 3/16	LB	5.46
			CM	25.3	44.6	10.6	KG	2.5
MD-015		Hand Gel Bottle Holder Holds one bottle of hand gel Screw holes for wall mounting White ABS plastic	IN	4	6 11/16	3 3/8	LB	0.15
			CM	10.2	16.9	8.6	KG	0.1
MD-100		Dental Organizer Holds three boxes of gloves, two boxes of face masks, and quarter fold towels or patient bibs Keyholes for wall mounting Quartz ABS and bronze PETG plastic	IN	17 5/8	23 1/2	5 1/16	LB	4.40
			CM	44.7	59.7	12.9	KG	2.0
MP-035		Sign Holder Optional accessory that attaches to the top of the surgical face mask dispenser FP-400 Clear PETG plastic	IN	8 1/2	11	1/4	LB	0.85
			CM	21.59	27.94	.64	KG	0.4
MP-080		Sign Holder Holds 8 1/2" x 11" signage vertically Hardware included for mounting to Bowman hand sanitizer dispensing station (WD-015 - sold separately) Clear PETG plastic	IN	8 5/8	13 1/4	1/4	LB	1.10
			CM	21.9	33.7	.6	KG	0.5
MW-001		Biohazard Bag Holder Holds a one gallon biohazard bag Screw holes for wall mounting Coated wire	IN	9 1/2	12 7/8	5 1/4	LB	1.65
			CM	24.1	32.7	13.3	KG	0.7
MW-003		Biohazard Bag Holder Holds a three gallon biohazard bag Screw holes for wall mounting Coated wire	IN	11 3/4	15 7/8	7 1/2	LB	2.10
			CM	29.8	40.3	19.1	KG	1.0



## Specialty Dispensers

Part Number	Image	Description	Units	W (L)	H	D	Weight	
MW-005		Biohazard Bag Holder Holds a five gallon biohazard bag Screw holes for wall mounting Coated wire	IN	13 5/16	19	7 1/2	LB	2.70
			CM	33.8	48.3	19.1	KG	1.2
NC001-0512		Bedpan/Urinal Dispenser Holds standard size bedpans and urinals Keyholes for wall mounting Quartz powder coated aluminum	IN	12 5/16	12	4 11/16	LB	1.85
			CM	31.3	30.5	11.8	KG	0.8
NP-600		Sickness Bag Dispenser Holds disposable sickness bags Keyholes for wall mounting Clear PETG plastic	IN	6 1/16	6 1/4	3	LB	0.45
			CM	15.4	15.9	7.6	KG	0.2
PS004-0111		Bags on Demand Dispenser Holds three boxes of gloves and one roll of bags (garbage, bio, laundry, etc.) Keyholes for wall mounting Clear PETG plastic	IN	10 1/8	20 3/8	3 15/16	LB	2.75
			CM	25.7	51.8	10.0	KG	1.2
PS004-0212		Bags on Demand Dispenser Holds three boxes of gloves and one roll of bags (garbage, bio, laundry, etc.) Keyholes for wall mounting Quartz ABS plastic	IN	10 1/8	20 3/8	3 15/16	LB	2.30
			CM	25.7	51.8	10.0	KG	1.0
QB-001		Cup Dispenser Holds disposable cups that dispense from the bottom of the unit Screw holes for wall mounting White powder coated metal	IN	3	8 1/2	3	LB	1.00
			CM	7.6	21.6	7.6	KG	0.5
RC001-0111		Manual Ventilator Dispenser Holds up to three manual ventilators in divided sections with one hinged lid covering all sections Keyholes for wall mounting Clear PETG plastic with quartz ABS plastic hinged lid	IN	19 7/8	17 1/16	6 1/8	LB	5.05
			CM	50.5	43.4	15.5	KG	2.3
RG-006		Quick Reference Card for Transmission Based Precautions - Horizontal Provides a quick reference to the HICPAC/CDC guidelines for precautions required for frequently Isolated Organisms PVC index card attaches to name badge holder	IN	3 3/8	2 1/4	1/16	LB	0.0
			CM	8.6	5.7	0.2	KG	0.0
RG-008		Quick Reference Card for Transmission Based Precautions - Vertical Provides a quick reference to the HICPAC/CDC guidelines for precautions required for frequently Isolated Organisms PVC index card attaches to name badge holder	IN	2 1/4	3 3/8	1/16	LB	0.0
			CM	5.7	8.6	0.2	KG	0.0
RP-030		Gown Dispenser Holds a box of disposable isolation gowns Keyholes for wall mounting Clear PETG plastic	IN	7 15/16	9 7/8	4 3/4	LB	0.85
			CM	20.2	25.0	12.0	KG	0.4

## Specialty Dispensers

Part Number	Image	Description	Units	W (L)	H	D	Weight	
RP-900		Apron Dispenser Holds aprons in bulk with a hinged lid Keyholes for wall mounting Clear PETG plastic	IN	15 7/16	11 7/16	4 5/16	LB	2.60
			CM	39.2	29.1	10.9	KG	1.2
SD-010		Surgical Organizer Two bulk areas on top holds a variety of personal protective apparel such as bouffant caps, shoe covers, etc. Compartment on bottom holds a variety of gowns Keyholes for wall mounting Clear PETG plastic on top front, white ABS plastic on bottom, back, and sides	IN	12 3/8	30 11/16	6 1/2	LB	5.85
			CM	31.4	78.0	16.5	KG	2.7
SP-003		Shoe Cover Dispenser Holds a box of shoe covers Keyholes for wall mounting Clear PETG plastic	IN	10 1/2	10 3/8	7	LB	1.10
			CM	26.7	26.3	17.7	KG	0.5
SP-573		Shoe Cover Dispenser Holds a box of shoe covers Keyholes for wall mounting Clear PETG plastic	IN	12 3/8	10 3/8	2 7/16	LB	0.95
			CM	31.5	26.3	6.2	KG	0.4
TB-002		Towel Dispenser Holds packages of quarter-fold towels Dispenses from the side or bottom of unit Keyholes for wall mounting White powder coated metal	IN	11 1/4	8 3/4	3 3/4	LB	2.0
			CM	28.6	22.2	9.5	KG	0.9
TB-003		Towel Dispenser Holds packages of quarter-fold towels Dispenses from the side or bottom of unit Keyholes for wall mounting White powder coated metal	IN	11 1/4	15 1/4	3 3/4	LB	3.85
			CM	28.6	38.7	9.5	KG	1.7
WD-015		Hand Sanitizing Dispensing Station Holds a pump or foam style hand sanitizer dispenser (sold separately) Screw holes for wall mounting Quartz ABS plastic	IN	7 7/8	14	5 1/2	LB	1.00
			CM	20.0	35.6	14.0	KG	0.5
WD-120		Wet Wipe Dispenser Holds a variety of wet wipe canisters Clips onto Bowman protection organizers Quartz ABS plastic	IN	6 1/4	11 3/8	6 3/8	LB	1.00
			CM	15.9	28.9	16.2	KG	0.5
WP-110		Bottle Holder Holds one bottle Keyholes for wall mounting Clear PETG plastic	IN	4	3 7/8	4 5/16	LB	0.30
			CM	10.2	9.8	11.0	KG	0.1

All consumable items are for demonstration purposes only and not included with the dispensers.

## Material Options

### Built to Last

Bowman® dispensers are crafted from the most durable materials available.

STAINLESS STEEL

POWDER COATED METAL

PETG PLASTIC

HIGH IMPACT PLASTIC

SINTRA® PLASTIC

#### STAINLESS STEEL

- Easy to clean and sterilize
- Attractive appearance
- Durable
- Corrosion resistant

#### PETG

- 15 to 20 times tougher than acrylic
- Resists weather and a variety of common cleaners
- Complies with FDA regulations for food contact
- Easy to clean
- Scratch resistant

#### HIGH IMPACT PLASTIC

- Cost Effective
- Tough, pliable, and attractive
- Used for industrial products

PROPERTIES COMPARISON	PETG	High Impact Plastic	Acrylic
IMPACT RESISTANCE	Very Good	Good	Poor
OPTICAL PROPERTIES	Good	Good	Very Good
CHEMICAL RESISTANCE	Very Good	Very Good	Poor
LONG TERM DURABILITY	Excellent	Very Good	Poor



**Distributed By:**

TOLL FREE  
800-962-4660  
PHONE  
360-435-5005  
FAX  
360-435-5277

ON-LINE  
[www.BowmanDispensers.com](http://www.BowmanDispensers.com)

EMAIL  
[customerservice@  
bowmandispensers.com](mailto:customerservice@bowmandispensers.com)

